

# DAILY REFERENCE GUIDE



**THANK YOU FOR BUYING A WHIRLPOOL PRODUCT.**  
 In order to receive a more complete assistance, please register your appliance on [www.whirlpool.eu/register](http://www.whirlpool.eu/register)

Before using the appliance, carefully read the *Health and Safety and Use and Care* guides.



Before using the machine, the transport bolts must be removed.

For more detailed instructions on how to remove them, see the *Installation Guide*.

## PRODUCT DESCRIPTION

### APPLIANCE

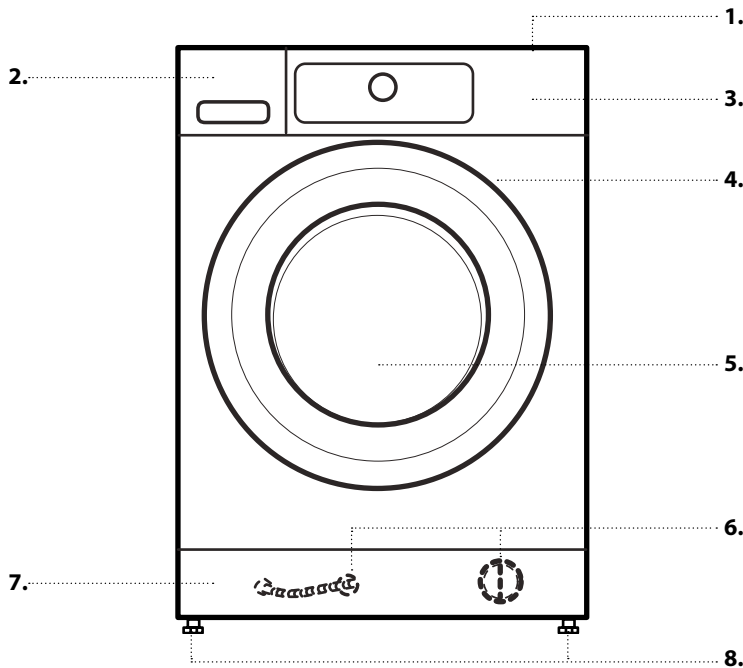

- 1. Worktop
- 2. Detergent dispenser
- 3. Control panel
- 4. Door handle
- 5. Door
- 6. Water filter/emergency drain hose (if available) - behind plinth -
- 7. Plinth (removable)
- 8. Adjustable feet (4)

### CONTROL PANEL

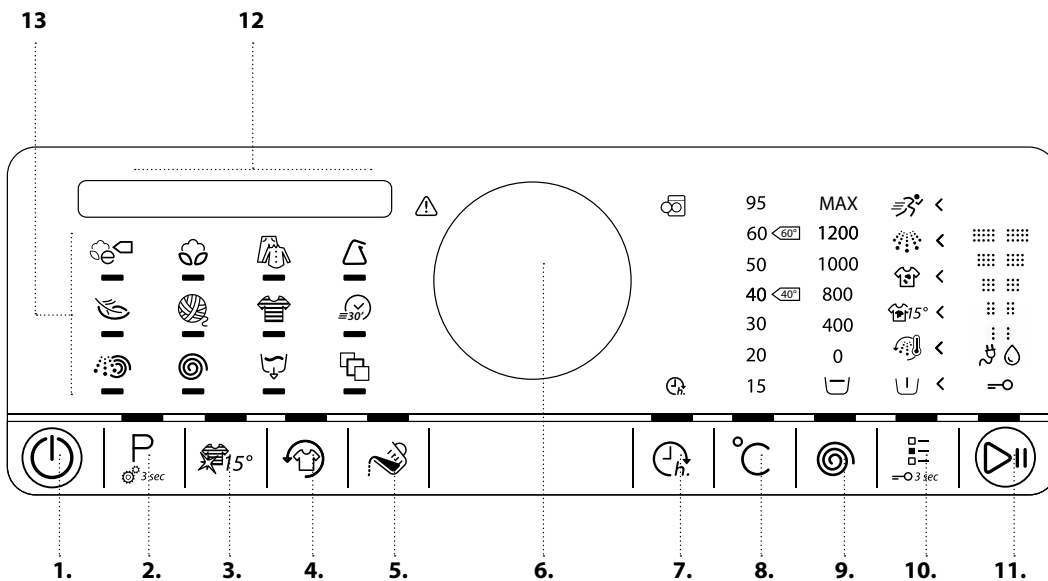

- 1. On/Off button (Reset/Drain if pressed and held down)
- 2. Programme button
- 3. Colours 15° button
- 4. Fresh Care button
- 5. Dosing Aid button
- 6. Knob (Turn to select/ Press to confirm)
- 7. Finish in button
- 8. Temperature button
- 9. Spin Speed button
- 10. Options button (Key lock if pressed and held down)
- 11. Start / Pause button
- 12. Display
- 13. Programmes area



SENSING THE DIFFERENCE

## DETERGENT DISPENSER



### 1. Main wash compartment

- Detergent for the main wash
- Stain remover
- Water softener



### 2. Prewash compartment

- Detergent for the prewash.



### 3. Softener compartment

- Fabric softener
- Liquid starch



**Pour in softener or starch solution only up to the “max” mark.**

### 4. Release button

(Press to remove the detergent dispenser for cleaning).



## DETERGENT RECOMMENDATIONS FOR VARIOUS TYPES OF LAUNDRY

White robust laundry	(cold-95°C)	Heavy duty detergents
White delicate laundry	(cold-40°C)	Mild detergents containing whitener and/or optical brighteners
Light/pastel colours	(cold-60°C)	Detergents containing whitener and/or optical brighteners
Intensive colours	(cold-60°C)	Colour detergents without whitener/optical brighteners
Black/dark colours	(cold-60°C)	Special detergents for black/dark laundry

## FIRST TIME USE

See the section on *DAILY USE* for information on how to select and start a programme.

### FIRST CYCLE

If you plug in the washing machine, it will switch on automatically. You will be asked to set the desired display language.

Turn the knob to select the language, and press the knob to confirm. Afterwards you can adapt the water hardness setting of your washing machine to your regional water hardness. This is recommended in order to optimize the Dosing Aid function.

Turn the knob to choose between soft / medium / hard and confirm by pressing the knob.

To remove any residues from the manufacturing process:

- Select the “*Cotton*” programme at a temperature of 95 °C
- Add a small amount of heavy duty detergent to the main wash compartment of the detergent dispenser (maximum 1/3 of the quantity recommended by the detergent manufacturer for lightly soiled laundry)
- Start the programme **without adding any laundry.**



## DAILY USE

See *Use and Care Guide* for more details on functions / see last page for information on how to obtain the *Use and Care Guide*

### 1. LOAD LAUNDRY

- Prepare your laundry according to the recommendations in section “*HINTS AND TIPS*”.
- Make sure that fasteners are closed and ribbons tied together, fasteners closed and ribbons tied together.
- Open the door and load the laundry. Observe the maximum load sizes given in the programme chart



### 2. CLOSE DOOR

- Make sure that no laundry gets stuck between door glass and rubber seal.
- Close the door so that you can hear it click shut.



### 3. OPEN THE WATER TAP

- Make sure that the washing machine is connected to the mains.
- Open the water tap



#### 4. SWITCH ON WASHING MACHINE

- Press the On/Off button until the programme button lights up. An animation appears, and there is a sound. Afterwards the washing machine is ready to be operated.



#### 5. SET THE DESIRED PROGRAMME

**GUIDED MODE** - the button light guides you through setting your programme in the following order: selection of programme / temperature / spin speed / options. As soon as you confirm a selection by pressing the knob, the button light will jump to the next step.

##### • Select programme:

Make sure that the programme button lights up. Turn the knob to select the desired Programme. Programme name and duration appear on the display. Confirm the desired programme by pressing the knob. The maximum possible laundry load for the selected programme is indicated after a few seconds.

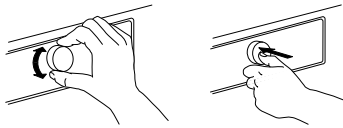

##### • Change temperature, if needed

If you want to change the temperature indicated over the temperature button, make sure that the Temperature button lights up. Turn the knob to select the desired temperature, then press the knob to confirm.



##### • Change spin speed, if needed

If you want to change the spin speed indicated over the Spin button, make sure that the Spin button lights up. Turn the knob to select the desired spin speed, or Rinse hold, then press the knob to confirm.



##### • Select options, if needed

Make sure that the options button lights up. The options which are selectable for your programme are indicated by lighting arrows.



Turn the knob to select the desired options. The symbol of the selected option blinks. To confirm it, press the knob.

Some options / functions can be selected by directly pressing the button:



Refer to section OPTIONS, FUNCTIONS AND INDICATORS for more information.

#### INDIVIDUAL MODE

After you have switched on the washing machine, you are not forced to follow the GUIDED MODE.

It is up to you which order you choose to set your programme. To do a setting, first press the relevant button, then turn the knob to select, and finally press the knob to confirm.

The range of temperatures, spin speeds and options depend on the programme selected. Therefore it is recommended to start your setting with selecting the programme.

#### 6. ADD DETERGENT

- If you do **not** use the Dosing Aid function, pull out the detergent dispenser and add detergent (and additives/softener) now, as indicated in section DETERGENT DISPENSER.

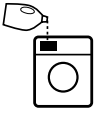

Observe the dosing recommendations on the detergent pack. If you have selected PREWASH or FINISH IN, observe the recommendations in section OPTIONS, FUNCTIONS AND INDICATORS. Afterwards carefully close the detergent dispenser.

- If you use the "Dosing Aid" function, add detergent later, after you have started the programme. Refer to section OPTIONS, FUNCTIONS AND INDICATORS.
- After having added detergent /additives, do not open the detergent dispenser anymore, to avoid overflow.



#### 7. START PROGRAMME

- Press and hold "Start/Pause" until the button lights up solidly; the programme starts.
- If you have selected "Dosing Aid", the washing machine will indicate you the recommended detergent amount for your laundry load **after** programme start. Follow the instructions as indicated in section OPTIONS, FUNCTIONS AND INDICATORS / Dosing Aid.



#### 8. CHANGE A RUNNING PROGRAMME, IF NEEDED

You can still change the settings while a programme is running. The changes will be applied, provided the respective programme phase has not finished yet.

- Press the relevant button (for example the "Spin speed" button to change the spin speed). The value blinks for a few seconds.
- While blinking, you can adjust the setting by turning the knob. If the value stopped blinking, press the button again.
- Press the knob to confirm the modification. If you do not confirm, the modification is confirmed automatically – the modified setting stops blinking.

The programme will continue automatically.

- To change the settings of a running programme, you can also Press "Start/Pause" to put the running programme on pause.
- Change your settings
- Press "Start/Pause" again to continue the programme.

#### 9. PAUSE A RUNNING PROGRAMME AND OPEN THE DOOR, IF NEEDED

- Press and hold "Start/Pause" to pause a running programme.
- Provided water level is not too high, or laundry is not too hot, the door indicator lights up. You can open the door, for example to add/remove laundry.
- Close the door again and press "Start/Pause" to proceed with the programme.



#### 10. RESET A RUNNING PROGRAMME, IF NEEDED

- Press and hold the "On/Off" button until the display indicates that the programme is cancelled. The water drains, the programme ends and the door unlocks.



#### 11. SWITCH OFF THE WASHING MACHINE AFTER PROGRAMME END

- The display indicates that the cycle is finished, and the "Door open" indicator lights up – you can take out your laundry
- Press "On/Off" to switch off the washing machine. If you do not switch it off, the washing machine will switch off automatically after about a quarter of an hour after programme end, to save energy.
- Leave the door ajar, so that the inside of the washing machine can dry.



# SETTINGS

The following settings can be changed / selected:  
 Display language / key tones / cycle end alert/ display contrast / water hardness / dosing aid (adjust dosing amounts for the detergents you use) / eco mode (automatic switch-off function after programme end) / return to factory settings.

- Press and hold the Programme button for at least 3 seconds.
- Turn the knob to select the setting which you want to change; confirm it by pressing the knob.

- Turn the knob to adjust the setting; confirm by pressing the knob.
- To exit the Settings mode, either turn the knob until the display indicates that you can exit – then confirm by pressing the knob. Or alternatively press the Programme button.

## HINTS AND TIPS

### **SORT YOUR LAUNDRY ACCORDING TO**





- Type of fabric / care label (cotton, mixed fibres, synthetics, wool, handwash items)
- Colour (separate coloured and white items, wash new coloured articles separately)
- Size (wash items of different sizes in the same wash load to improve washing efficiency and distribution in the drum)
- Delicates (wash small items – like nylon stockings – and items with hooks – like bras – in a cloth bag or pillow case with zip).

### **EMPTY ALL POCKETS**

- Objects like coins or safety pins can damage your laundry as well as the drum.

### **WASH CARE LABELS**

The temperature in the washtub symbol indicates the maximum possible temperature for washing the item.

-  Normal mechanical action
-  Reduced mechanical action
-  Much reduced mechanical action
-  Hand wash only
-  Do not wash

### **CLEAN THE WATER FILTER REGULARLY**



- Helps to avoid that it can get clogged and that the drain water cannot be pumped out anymore. Refer to section CARE AND MAINTENANCE / “Cleaning the water filter” in the Use and Care guide.

### **SAVINGS AND ENVIRONMENT**

- Achieve the best use of energy, water, detergent and time by using the recommended maximum load size for the programmes, as indicated in the programme chart.
- Do not exceed the detergent dosages indicated in the detergent manufacturer’s instructions. Use the Dosing Aid function.
- Save energy by using a 60 °C instead of a 95 °C wash programme or a 40 °C instead of a 60 °C wash programme. For cottons, the Eco Cotton  programme at 40 °C or 60 °C is recommended.
- Save energy and time by selecting a high spin speed to reduce the water content in the laundry before using a tumble dryer.

## CONSUMPTION DATA

*This data may differ in your home due to changing conditions in inlet water temperature, water pressure etc.*

PROGRAMME	TEMPERATURE (°C)	LOAD (KG)	WATER (L)	ENERGY (KWH)	APPROXIMATE PROGRAMME DURATION (H:MIN)		APPROXIMATE REMAINING MOISTURE CONTENT (%)
					WITHOUT RAPID	WITH RAPID	
Mixed	40	6.0	61	0.28	01:00	00:55	55
Cotton	95	10.0 (max)	99	2.80	02:50	–	55
Cotton	60	10.0 (max)	97	1.80	02:35	01:55	55
Cotton	40	10.0 (max)	88	0.88	03:30	02:10	55
Synthetics	60	3.5	46	0.96	02:20	01:20	35
Synthetics	40	3.5	46	0.66	02:20	01:20	35
ECO COTTON 	60	10.0 (max)	60	0.95	06:00	04:00	53
ECO COTTON 	60	5.0	40	0.73	03:30	*	53
ECO COTTON 	40	5.0	40	0.71	03:30	*	53

Values measured in normal conditions in accordance with IEC/EN 60456. Water, energy and remaining moisture content values refer to the default setting of the programmes, without options.

max = maximum load capacity of the washing machine

Acoustic values on declaration label refer to appliance after complete installation, with acoustic pads fixed on bottom of washing machine according to separate instructions.

\* Duration indicated after load sensing

**Eco Cotton** is the standard programme for washing normally soiled cottons, and it is the most efficient programme in terms of combined water and energy consumption. For reasons of energy saving, the real water temperature may deviate from the specified cycle temperature.

Power consumption in off-mode is 0.25 W/in left-on mode 0.25 W.

# PROGRAMME CHART

Programme	Care labels	Temperature °C	Max load (Kg)	Selectable using the Options button						Selectable directly				Spin		Detergent and additives			
				Prewash	Hot Finish	Bio Strain 15	Heavy Soil	Intensive Rinse	Rapid	Colours 15°	Fresh Care	Dosing Aid	Finish in	Max. spin speed (rpm)	Rinse hold	Prewash	Main Wash	Softener	
ECO COTTON		Cold/60°C	max	—	—	—	—	✓	✓	✓	✓	✓	✓	✓	max	✓	—	●	○
COTTON		Cold/95°C	max	✓	✓	✓	✓	✓	✓	✓	✓	✓	✓	✓	max	✓	○	●	○
MIXED		Cold/60°C	6.0	—	✓	✓	—	✓	✓	✓	✓	✓	✓	✓	max	✓	—	●	○
SYNTHETICS		Cold/60°C	3.5	✓	—	✓	✓	✓	✓	✓	✓	✓	✓	✓	max	✓	○	●	○
DELICATES		Cold/40°C	2.5	✓	—	—	—	—	✓	✓	✓	✓	✓	✓	1000	✓	○	●	○
WOOL		Cold/40°C	2.0	—	—	—	—	—	✓	✓	✓	✓	✓	✓	1000	✓	—	●	○
COLOURS		Cold/60°C	6.0	✓	—	✓	✓	—	✓	✓	✓	✓	✓	✓	1000	✓	○	●	○
RAPID 30'		Cold/30°C	3.0	—	—	—	—	—	—	✓	✓	✓	✓	✓	max	✓	—	●	○
RINSE&SPIN		—	max	—	—	—	—	✓	—	—	✓	—	✓	✓	max	✓	—	—	○
SPIN		—	max	—	—	—	—	—	—	—	✓	—	✓	✓	max	—	—	—	—
DRAIN		—	max	—	—	—	—	—	—	—	✓	—	✓	✓	—	—	—	—	—
SHIRTS		Cold/40°C	2.5	✓	—	—	—	—	✓	✓	✓	✓	✓	✓	1000	✓	○	●	○
DUVET		Cold/60°C	3.0	✓	✓	✓	—	✓	✓	✓	✓	✓	✓	✓	1000	✓	○	●	○
BED LINEN		Cold/60°C	3.5	✓	✓	✓	—	✓	✓	✓	✓	✓	✓	✓	max	✓	○	●	○
CASHMERE		Cold/30°C	2.0	—	—	—	—	—	✓	✓	✓	✓	✓	✓	400	✓	—	●	○
SPORT		Cold/40°C	3.5	✓	—	✓	—	✓	✓	✓	✓	✓	✓	✓	max	✓	○	●	—
JEANS		Cold/60°C	5.0	✓	✓	✓	✓	✓	✓	✓	✓	✓	✓	✓	1000	✓	○	●	○
BABY ITEMS		Cold/60°C	5.0	✓	✓	✓	✓	✓	✓	✓	✓	✓	✓	✓	1000	✓	○	●	○
MINI LOAD		Cold/40°C	1.0	—	—	—	—	✓	✓	✓	✓	✓	✓	✓	max	✓	—	●	○

Selectable/optional   
 — Not selectable/applicable   
 ● Dosing required   
 ○ Dosing optional

# PROGRAMMES

Observe the recommendations on the care labels of your laundry.

## ECO COTTON

Normally soiled cotton laundry. At 40°C and 60°C standard cotton programme and most favourable programme in terms of combined water and energy consumption for washing cotton laundry.

The values on the Energy label are based on this programme



## COTTON

Normally to heavily soiled and robust cotton and linen laundry, such as towels, underwear, table linen etc.



## MIXED

Lightly to normally soiled robust laundry made of cotton, linen, artificial fibres and their blends. 1-hour programme.



## SYNTHETICS

Normally soiled laundry made of artificial fibres (like polyester, polyacryle, viscose etc.) or their blends with cotton.



## DELICATES

Fine laundry made of delicate fabrics, which needs gentle treatment.



## WOOL

Woolens, labeled with the Woolmark and identified as machine washable, as well as textiles made of silk, linen, wool and viscose marked as handwashable.



## RAPID 30'

Lightly soiled laundry made of cotton, synthetics and their blends. Refresh programme for laundry without stains.



## COLOURS

Lightly to normally soiled laundry made of cotton, synthetics or their blends; also delicates. Helps preserving colours.



## RINSE AND SPIN

Separate rinse and intensive spin programme. For robust laundry.



## SPIN

Separate intensive spin programme. For robust laundry.



## DRAIN

Separate programme to drain the water, without spinning.



## SPECIAL PROGRAMMES

To set one of the following programmes, select and confirm the special programmes position. Then turn the knob to select one of the following eight programmes; the display indicates the programme name. Confirm the desired programme by pressing the knob.



### SHIRTS

Shirts, blouses and fine business clothes made of cotton, synthetics or their blends.

### DUVET

Big items such as sleeping bags, washable blankets, bathmats, pillows and duvets filled with feathers or synthetic material.

### BED LINEN

White or coloured bed linen made of cotton and synthetic fibers, or blends of both.

### CASHMERE

High-quality cashmere garments identified as machine washable or hand washable.

### SPORT

Normally soiled and sweaty sportswear made of cotton jersey or microfibers. Includes a prewash cycle – you can add detergent also to the prewash chamber. Do not use softener.

### JEANS

Normally soiled cotton jeans-wear and garments made of robust jeans-like material, such as trousers and jackets.

### BABY ITEMS

Normally soiled baby clothes made of cotton and/or linen. The suds are rinsed out even more thoroughly, which helps to protect sensitive baby skin.

### MINI LOAD

Cotton and/or synthetic laundry made of stable fabric types. Ideal programme for washing a small laundry load in an economic way.

# OPTIONS, FUNCTIONS AND INDICATORS

Refer to the Programme Chart to check if options are available for the selected programme

## OPTIONS which are directly selectable by pressing the dedicated button

### Colours 15°

Helps to preserve the colours of your laundry by washing it with cold water (15°C). Saves energy for water heating, while keeping a good wash result. Suitable for lightly soiled coloured laundry without stains.

- Make sure that your detergent is suitable for cold wash temperatures (15 or 20 °C).
- Not selectable for Cotton 95°.



### Fresh Care

Helps to keep your laundry fresh if you cannot unload it soon after programme end. The washing machine will start to tumble the laundry periodically a short time after programme end. This tumbling will last up to approximately 6 hours after end of your wash programme. You can stop it at any time by pressing any button; the door unlocks and you can take out your laundry.



## Dosing Aid

Helps to dose the right amount of detergent for your laundry load.

Prepare the option as described in DOSING AID / FIRST USE in the Use and Care Guide.

- After you have loaded the laundry, closed the door and selected programme and options, press the Dosing Aid button. The button lights up.
- Start the programme by pressing "Start/Pause". – The drum rotates to detect the laundry load; the display indicates the load sensing phase. On the control panel, an animation occurs. Afterwards the recommended detergent amount for the main wash compartment in ml appears on the display.



If you have selected "Prewash" option, the display alternately shows the amount for prewash (I) and main wash (II) compartment.

- Pull out the detergent dispenser and pour the recommended detergent quantity into the main wash (II) and, if Prewash is selected, also into the prewash (I) compartment of the detergent dispenser.
- Close the detergent dispenser (or the door) and press "Start/Pause" to continue the programme.

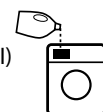

**OPTIONS which are selectable by pressing the Options button**



**Prewash**

Helps to clean heavily soiled laundry by adding a prewash phase to the wash programme selected.

Extends the programme by about 20 minutes.

Add detergent to the prewash compartment of the detergent dispenser as well, or directly into the drum. Use powder detergent for the main wash in order to ensure that the detergent stays in the detergent dispenser until the start of the main wash phase.

**Hot Finish**

The programme ends with a warm rinse phase. This relaxes the fibres of your laundry, and the laundry feels comfortably warm when taking it out a short time after programme end.



**Bio Stains 15°**

Helps to remove all kinds of stains, except grease/oil. The programme begins with a cold water wash phase. Extends the programme by about 10 minutes. Pre-treatment recommended for stubborn stains. Not selectable for Cotton 95°C.



**Heavy Soil**

Helps to clean heavily soiled, stained laundry by optimising the efficiency of additives for stain removal. Add an appropriate amount of in-wash additive for stain removal (powder) to the main wash compartment, together with your detergent (powder only). May extend the programme by up to 15 minutes.



Appropriate for use with oxygen-based stain removers and bleaching agents.

**Chlorine or perborate bleaches must not be used!**

**Intensive Rinse**

Helps to avoid detergent residues in the laundry by extending the rinse phase. Particularly suitable for washing baby laundry, for people suffering from allergies and for areas with soft water.



**Rapid**

Enables quicker washing. Recommendable for only lightly soiled laundry. Not selectable for Cotton 95 °C.



**FUNCTIONS**

**Rinse hold**

Avoids automatic spinning of the laundry at the end of the programme. The laundry remains in the last rinse water, the display indicates the rinse hold and the programme does not continue.



Suitable for delicate laundry which is not appropriate for spinning, or which should be spun with a low spin speed. Not suitable for silk. To end the "Rinse hold" function, choose between:

- **drain the water, no spin:** turn the knob to select spin speed "0" and press Start/Pause: the water will be drained and the programme ended
- **spin the laundry:** the default spin speed blinks - start the spin cycle by pressing Start/Pause. Or select a different spin speed by turning the knob, press it to confirm, and press Start/Pause.



**Finish in**

Enables to have the laundry ready at a particular time by setting a delay until end of the programme.



Choose a delay up to 23 hours. Do not use liquid detergent with this function.

- Select programme, temperature and options.
  - Press the "Finish in" button – the symbol over the button lights up.
  - Turn the knob to select a delay up to 23 hours. Confirm the desired delay by pressing the knob.
  - When you have finished your settings, press "Start / Pause" - the countdown of the delay starts. The display indicates that Finish in is active and that the washing machine is in waiting mode.
  - The programme starts automatically, in time to be finished at the end of the delay period. On programme start, the delay on the display is replaced by the remaining programme duration.
- To cancel the delay
- either press "Start/Pause" to cancel the delay; to start the selected programme immediately, press "Start/Pause" again
  - or press and hold "On/Off" to cancel the complete programme setting.



**Key lock**

To lock the buttons and knob of the control panel against unwanted operation.

To lock:

- The washing machine must be switched on.
- Press and hold the option key until the key symbol on the control panel lights up. Knob and keys are locked now. Only "On/Off" works.

If you switch the washing machine off and on again, the key lock will remain active until you unlock it.

To unlock: press and hold the option key again for at least 3 seconds, until the key symbol goes off.

**INDICATORS**

**Door can be opened**

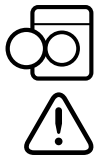

**Failure:** Observe the display message.

For any failures, refer to section Troubleshooting in the "Use and Care Guide".

**Energy / Water monitor**

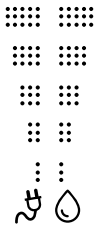

Gives feedback about the energy and water consumption of your programme setting. The less indicators light up, the more economic is your programme setting. Can still adapt after sensing phase of laundry load.

**Descaling**

A display message will remind you regularly to descale the washing machine. Find descaler appropriate for the washing machine on [www.whirlpool.eu](http://www.whirlpool.eu).

To cancel the display reminder, press the knob.

---

## MAINTENANCE AND CLEANING AND TROUBLESHOOTING

For maintenance and cleaning, and for troubleshooting, see the **Use and Care Guide**.

The **Use and Care Guide** can be obtained as follows:

- After-Sales Service; using the phone number in the warranty booklet
- Download from the Whirlpool Website <http://docs.whirlpool.eu>



## CONTACTING AFTER-SALES SERVICE

Provide both numbers shown on the service sticker inside the door when contacting the After-Sales Service team.

<http://www.whirlpool.com>

The phone number can be found in the warranty booklet.



400010793815

---

Whirlpool® Registered trademark/TM Trademark of Whirlpool group of companies -  
© Copyright Whirlpool Europe s.r.l. 2014. All rights reserved - <http://www.whirlpool.eu>

